

1 Keyboard Tricks

Table of contents

1	Keyboard Tricks.....	1
1.1	Breaks and Variations	2
1.1.1	Variation	2
1.1.2	Break using 3 fingers = Drums will play	2
1.1.3	Break using 4 fingers = Drums AND Bass will play.....	2
1.2	Connect USB Drive to keyboard AND computer	2
1.2.1	The Yamaha Way	2
1.2.2	My way	3
1.3	Sound through the keyboard/computer.....	4
1.3.1	Sound through the computer	4
1.3.2	Sound through the keyboard.....	5
1.3.3	If you don't have a free COM Port.....	6
1.4	Catch Display to Image File	6
1.4.1	Tyros 5; PSR S910 and PSR S750.....	6
1.4.2	Genos	7
1.5	Import and Use Ins Files	7
1.5.1	To Import Instrument Definitions	8
1.5.2	Changing the Patch in Cakewalk's Track View	9
1.5.3	Changing the Patch in Sonar	10
1.6	Yamaha Expansion Pack.....	11
1.6.1	What is Expansion Packs	11
1.6.2	Software for Expansion Packs	11
1.7	CASM High Limit and Low Limit.....	12

1.1 Breaks and Variations

This page describes some methods for getting special breaks and variations at a Yamaha keyboard.

1.1.1 Variation

If you tap a Main button **twice rapidly**, the Main will change **WITHOUT** playing a fill in.

1.1.2 Break using 3 fingers = Drums will play

When playing in the ACMP mode AND using Fingered 1 or 2 fingering, a break can be made by pressing any **THREE** close notes (e.g. F, F# and G) at the left side of the split point.

Now only the drum channels will be playing until you play a chord with your left hand.

1.1.3 Break using 4 fingers = Drums AND Bass will play

When playing in the ACMP mode AND using Fingered 1 or 2 fingering, a break can be made by pressing any **FOUR** close notes (e.g. E, F, F# and G) at the left side of the split point.

Now only the drum and the bass channels will be playing until you play a chord with your left hand.

The bass channel will play its pattern with the lowest note of the four notes pressed as the root note. In the example above the bass pattern will be played with E as root.

1.2 Connect USB Drive to keyboard AND computer

If your keyboard does not support data transfer using the Yamaha **Musicsoft Downloader** software program - or you do not want to use this - using USB drives for data transfer between a keyboard without HD and a computer is somewhat bothering.

At least the "Yamaha Way"...

1.2.1 The Yamaha Way

Remove USB storage device/cable from the keyboard and insert it into the computer. And vice versa.

Not THAT elegant!

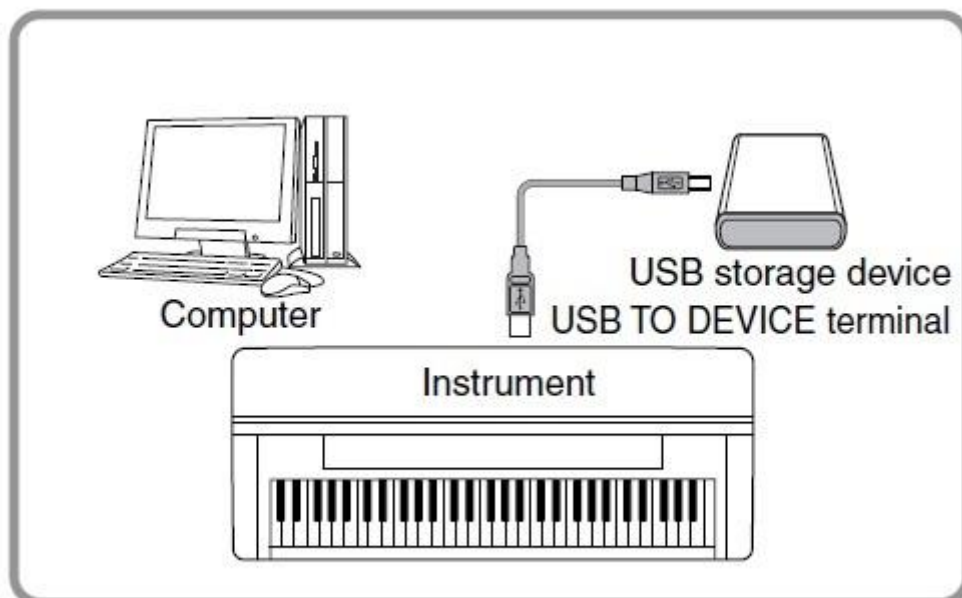

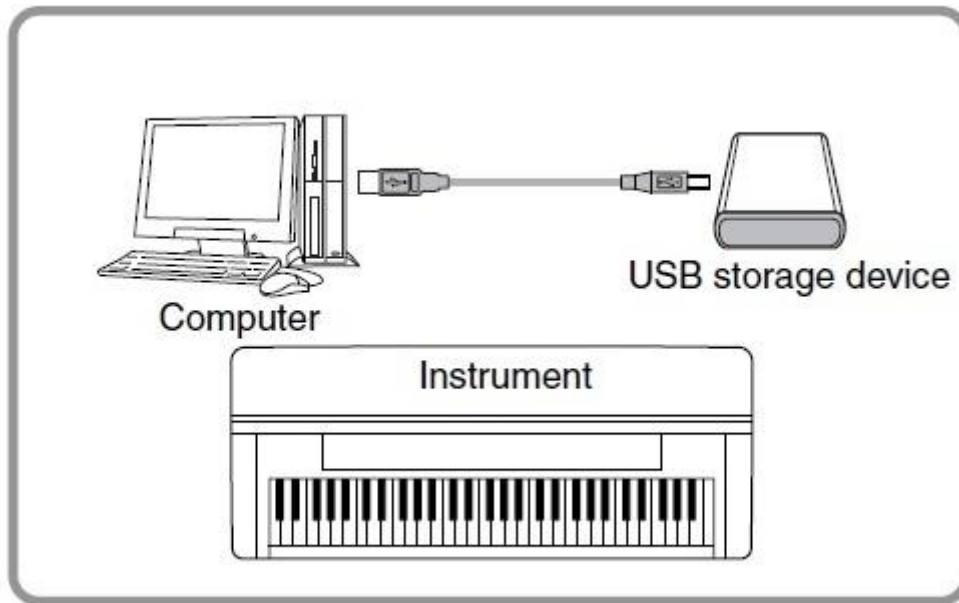

1.2.2 My way

This bother can be eliminated by installing a switchbox that enables you to use the same USB drive on one computer and one keyboard.

The USB drive connects to the switchbox, which then connects to the computer and the keyboard. You can then press a button on the box to change if the computer or the keyboard is connected to the USB drive.

Get a box from one of the sources below. You will need 2 USB cables for the connections. Both with a USB A connector in the one end, and with a USB B Connector in the other end.

Sources:

- <http://www.cwc-group.com/usbswitchub21b.html>
- http://www.ebay.com/itm/2-Port-2-Computers-Share-1-USB-Device-Printer-Scanner-Sharing-Switch-USB-2-0-/190738085464?pt=US_Video_Cables_Adapters&hash=item2c68e03658

Notice: You will get the "usual" warnings when toggling between devices (= inserting / removing a USB device). Just be sure you are not transferring files when toggling.



Press the red button at the switch box to connect/disconnect the USB storage device to the keyboard or to the computer.

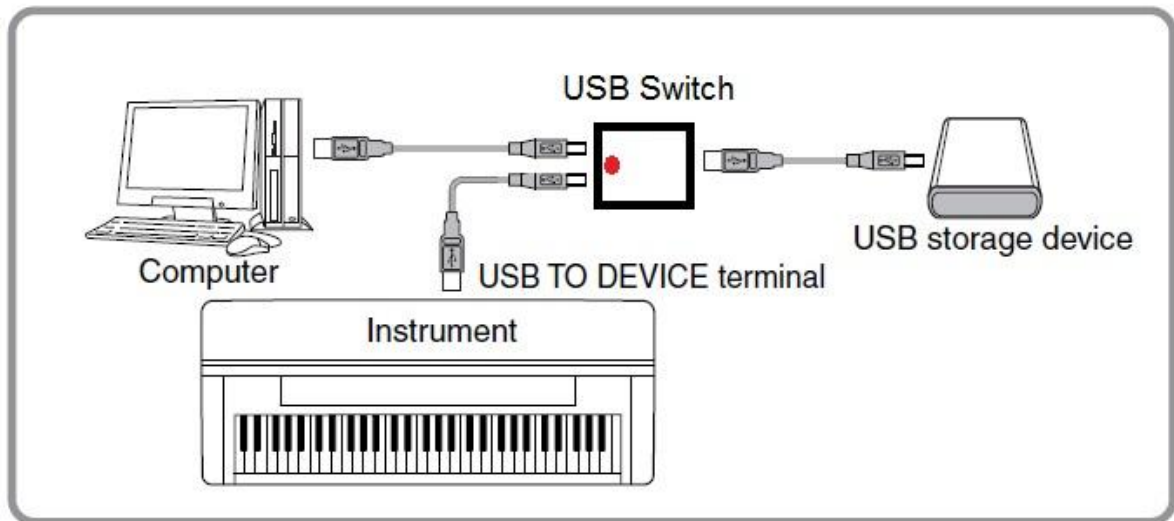

1.3 Sound through the keyboard/computer

This page describes methods of getting MIDI to sound through your computer or through your Yamaha keyboard.

Further information about MIDI play back in my software programs; and about connecting keyboards without USB ports.

1.3.1 Sound through the computer

Windows Vista, 7, 8 and 10

These OS versions has no build-in program for MIDI setup. Therefore you will need a program for this operation.

Get my **MIDI Out Setup** software program.

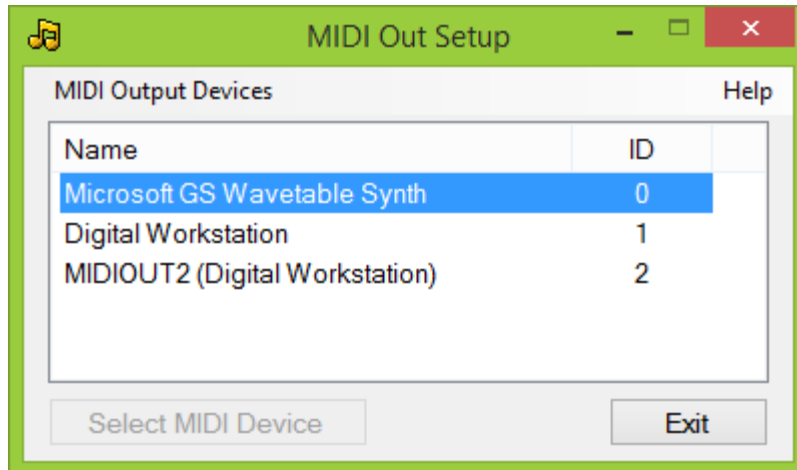

Windows XP and older

Select a MIDI device in the computer as shown at the image.

Configure in Windows Start > Settings > Control Panel > Sounds and Multimedia > Audio



(From a Danish Windows 2000 - other versions and languages looks similar)

1.3.2 Sound through the keyboard

If you want to use your keyboard for MIDI playback; you must

- Install the USB-MIDI driver software supplied with your keyboard. If you miss this, you can get it from Yamaha at http://www.yamahaproaudio.com/global/en/downloads/firmware_software/
- Get a USB cable with a USB A connector in the one end, and a USB B connector in the other end.
- Plug the USB A connector into the computer, and the USB B connector into the keyboard **USB To Host** port.

For further details consult your keyboard manual or the documentation with the driver software.

Sound in my Software Programs

A number of my software programs has MIDI play back features. In these programs you will find a MIDI Setup menu.

Notice if nothing is selected in these programs, the computers default MIDI play back device will be used.

For programs written in a .Net language, the default MIDI play back device is the one selected above. Other available MIDI devices can be selected in the program.

For programs written in Java, the default MIDI play back device is the "Real Time Sequencer", which is built-in in Java. Other available MIDI devices can be selected in the program.

Java has another built-in MIDI device named "Gervill".

Selecting a MIDI play back device is for use in the specific software program only; and does not change the MIDI device selection at the computer generally.

Keyboard without USB ports

In this case you must use a COM port at the computer, and the keyboard **To Host** terminal.

- Connect your keyboard and your PC with the "To Host" cable, which comes with your keyboard (or buy one). If you don't have a free COM Port at your PC, read below.
- Install the Yamaha CBX driver supplied with your keyboard. If you don't have it; get it from Yamaha at http://www.yamahaproaudio.com/global/en/downloads/firmware_software/mididrivers/cbx200w.jsp
- Be sure to set the switch at the rear side of your keyboard's "To Host" terminal to: PC2. Read the section about To Host terminal in your manual, if you are in doubt.

Select (like above) the "Yamaha CBX A Driver" as MIDI play back device.

1.3.3 If you don't have a free COM Port

Note: This paragraph is **not** relevant when the keyboard USB port is used.

Using the keyboard To Host terminal

- You need a free COM Port for the "To Host" cable.
- Most stationary computers have only one of these (which is often used by other devices, e.g. a modem); and many laptops don't have a COM Port at all.

If you have **no COM Port** at your PC

- Insert an extra card into your computer to get a COM Port.

or

- Use an USB Port if you have one of these (read below).

If you have **no free COM Port** at your PC

- Insert an extra card into your computer to get an extra COM Port.

or

- Plug and unplug the two cables which have to share the only COM Port. Don't plug or unplug while the computer is running.

or

- Use an USB Port if you have one of these (read below).

If you have **an USB port** at your PC

- Get a USB to Serial Port Converter cable, e.g TU-S9 from TRENDnet at <http://www.trendnet.com/>
- Plug the cable in the USB port.
- Windows will start the "Install new Hardware" wizard.
- Insert the CD supplied with the cable into your CD drive - and install the driver for the cable.
- Now your computer has a/an extra COM Port.
- Configure the Yamaha CBX Driver in Windows Start > Settings > Control Panel > Yamaha CBX Driver
- Select COM Port for the driver. If a computer has a COM Port this is by default COM1. Then choose COM3 for the Yamaha CBX Driver.

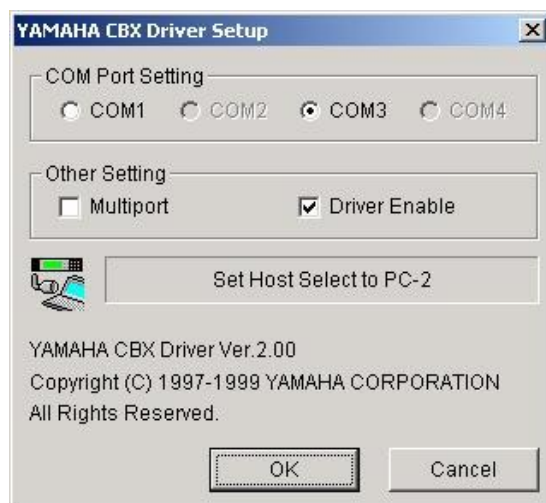

- Restart the computer.

1.4 Catch Display to Image File

The Display can be saved as an image to your USB pen.

1.4.1 Tyros 5; PSR S910 and PSR S750

and probably many more keyboard models...

The procedure is:

1. Turn off your keyboard
2. Connect the USB pen
3. Hold down button no. 3 and 4 in the first row and the first button in the second row in the keyboards Voice section

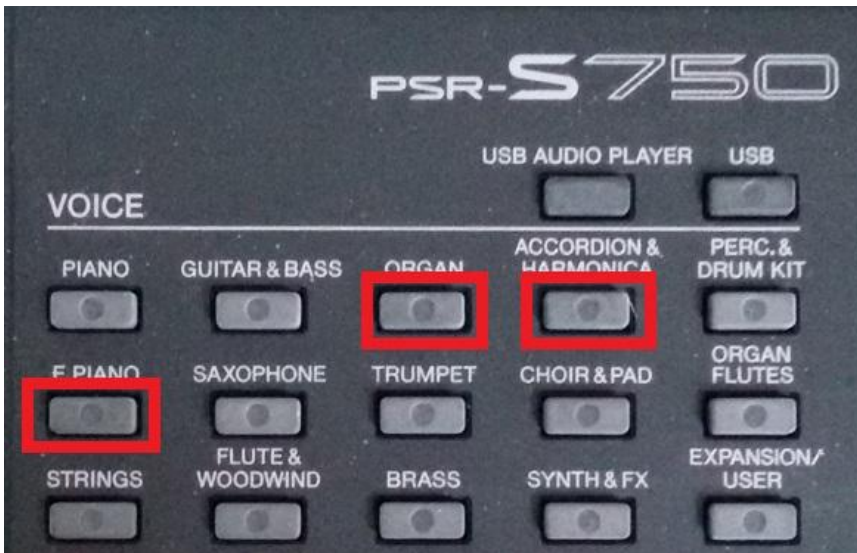

4. Turn on the power to your keyboard while holding down these three buttons
5. When the keyboard is ready release the three buttons

To save display click the Registration no. 8 button. The display is saved to a file, which is numbered automatically.

In this mode Registration no. 8 can NOT be reached by pressing the Registration no. 8 button.

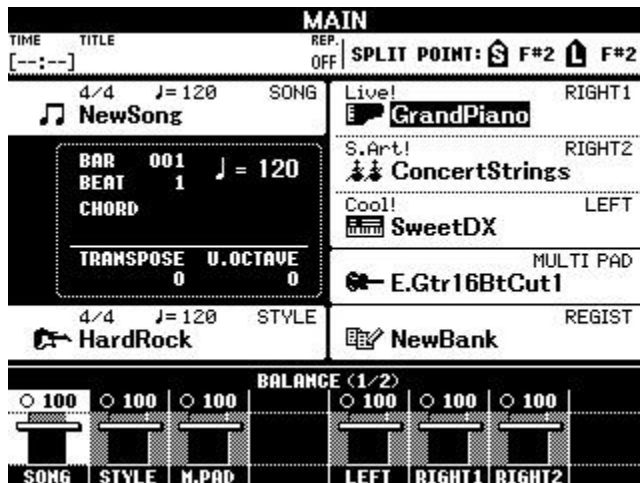

1.4.2 Genos

1. Insert USB stick
2. In the Style control section, hold down the "BREAK" and "ENDING 2" and "ENDING 3" buttons while turning on Genos
3. To take a screen copy, press "ONE TOUCH SETTING 4"
4. The images are stored on the USB stick (in the root folder and called CAPT000X)

1.5 Import and Use Ins Files

This page was originally written by Dan Phalen, Creston Hall. Reprinted with permission. Some minor changes have been added.

When you install Cakewalk™ or Sonar™, a few common instrument definitions are already set up for you and ready to use.

At Ins Files at http://www.jososoftware.dk/yamaha/ins_files.htm you will find many instrument definitions for the Yamaha Genos, Tyros and PSR series of keyboards.

Each instrument definition is stored in a file you can edit with any text editor. These files have the .ins name extension, such as PSR340.ins.

The name is not case-sensitive, so don't worry about mixing upper and lower case in the filename.

When you import an instrument definition, it is added to the master instrument definition file master.ins.

The contents of master.ins determines the list of instruments that appear in the Assign Instruments dialog box.

1.5.1 To Import Instrument Definitions

1. In Cakewalk or Sonar, choose the Options-Instruments menu to display the Assign Instruments dialog box.
2. Click Define to display the Define Instruments and Names dialog box.
3. Click Import to display the Import Instrument Definitions dialog box.
4. Navigate to the file that contains the PSR instrument definition you downloaded from this web site, "PSR540.ins" for example. Click Open. In the new panel, Cakewalk displays a list of all the instrument definitions in the file. Usually for a PSR instrument there is just one.
5. Chose one or more instruments from the list and click OK.
6. Click the Close button to close the Define Instruments and Names dialog box.

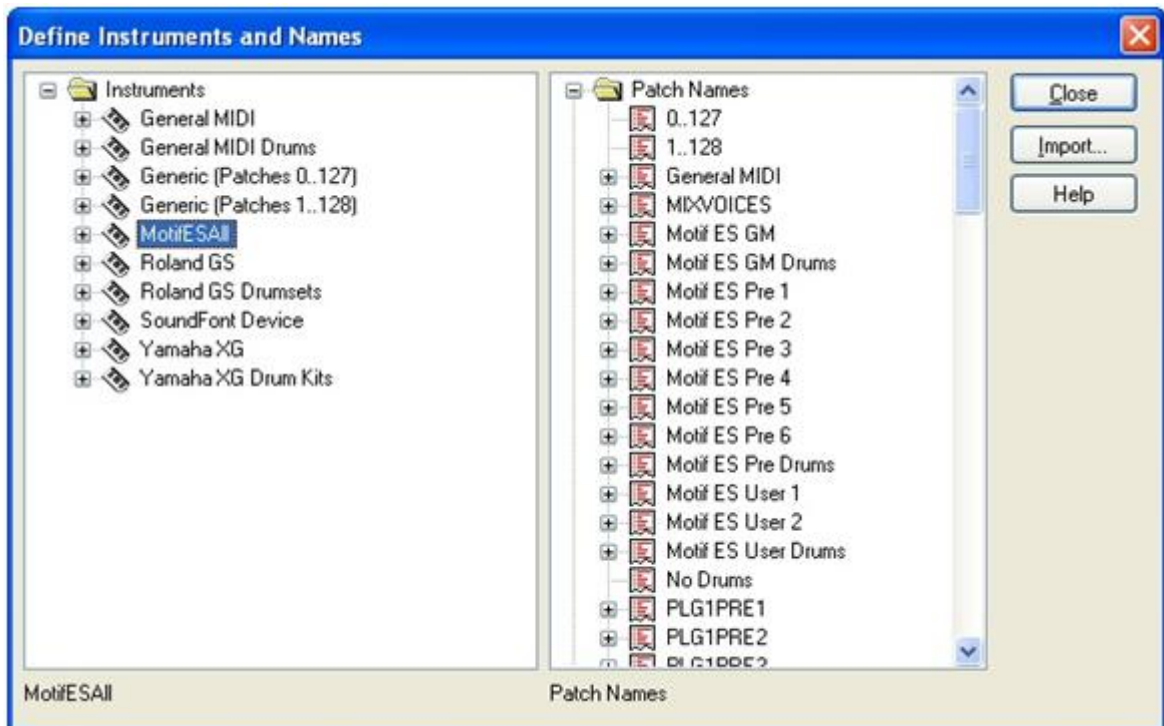

The instrument definitions you imported should now appear in the Assign Instruments dialog box as an item in the Uses Instrument list.

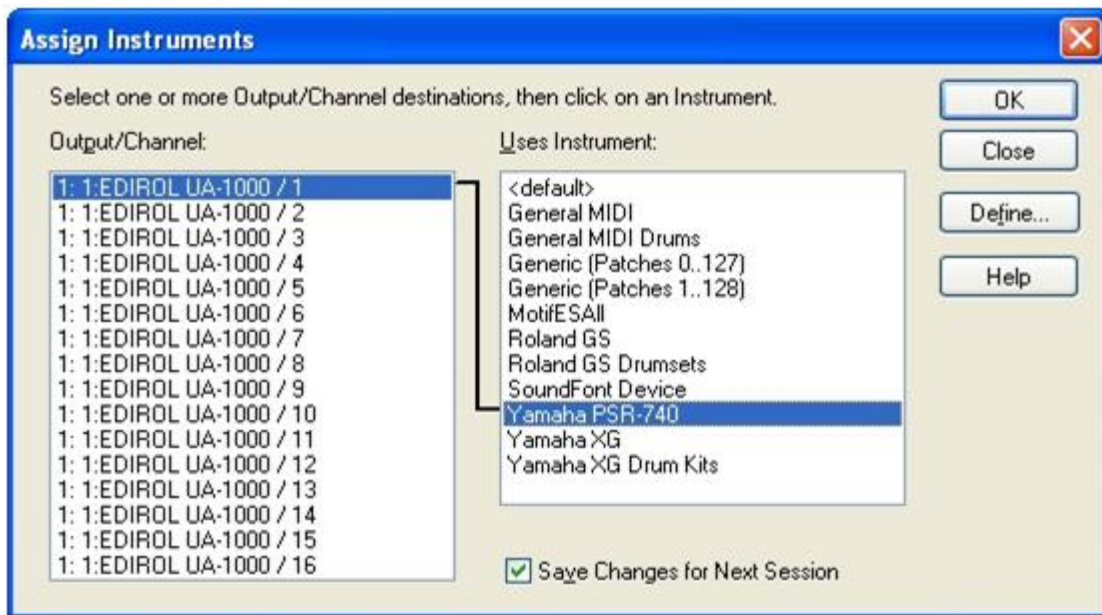

1.5.2 Changing the Patch in Cakewalk's Track View

Now that you have installed and imported your PSR instrument definition, it is time to put it to use in your Cakewalk project.

Using your instrument definition with Cakewalk is easy and powerful. Start out by opening the Track View of your song.

You can make patch changes for any track in the view either before or during song play. Let's try it with the song playing.

1. Right click on any column (except Bank and Patch) in the track you wish to change.
2. In the popup menu that opens, choose Track Properties to open the Track Properties dialog box.
3. Find the Patch setting. This setting indicates which patch, or instrument, is used by this track.
4. To change the patch, select a new patch from the drop-down list. Or, better yet, click the yellow icon button to the right of the Patch window. The Patch Browser dialog box pops up. In the window titled "Show Patches Containing the Text" type in a word or phrase. For example, if you wish to see a list of all piano instruments for your PSR, start typing in "pian". That's as far as you need to go. You'll see the list reduced to just the piano voices. Highlight one by clicking on it. Listen to the change in voice. You can experiment with different instrument voices until you find the one you want.
5. Now click OK. The Patch Browser dialog disappears. Your selection appears in the Patch pane of the Track Properties dialog box.
6. Click OK to save your new instrument for the track patch.

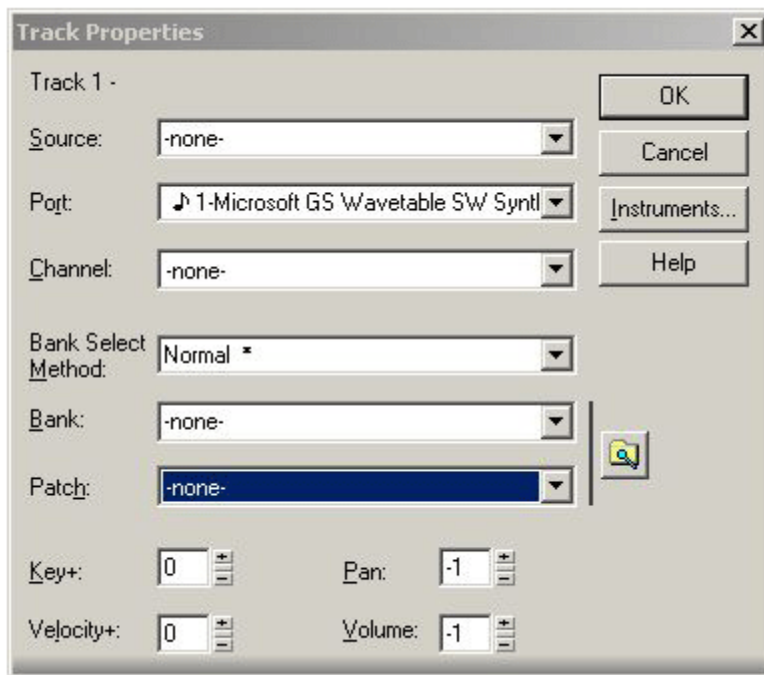

1.5.3 Changing the Patch in Sonar

Using your instrument definition with Sonar is much more powerful than before. With the improved user interface, the expanded track properties pane shows the same choices for which previous versions required a dialog box. Now the properties are embedded in the Track View window itself.

Thus, from the Track View, you can make patch changes directly either before or during song play.

1. Expand the track properties to expose the "Patch" button and click its opener icon. In Sonar 6 this is the triangle on the right end of the button.
2. When you click the opener, Sonar pops up the list of patch names available in the Patch Bank selected.

In the example, the patch bank is 8066-Motif ES Pre 3 and for the Yamaha Motif that bank will fill the popup with four columns of patch names, or, in Motif parlance, "voices." In our example above, I have chosen Big Brite from the brass category.



1.6 Yamaha Expansion Pack

1.6.1 What is Expansion Packs

A Yamaha Expansion Pack is a package which adds more content to the keyboard:

- Voices
- Styles (optional)

Voices and styles are merged into a file, having a "yep" or "ppi" extension.

Some expansion packs contain Registrations and/or MultiPads. These data are not included in the "yep/ppi" file.

Where to get

Expansion Packs can be obtained from Yamaha Shop at <http://www.yamaha.com>.

Besides the Expansion Packs for sale, some free Expansion Packs can be found at http://uk.yamaha.com/en/products/musical-instruments/keyboards/digitalkeyboards/arranger_workstations/awk/vse/

Interchangeability

Expansion Packs for Genos, Tyros 5, Tyros 4, PSR S970, PSR S770 and PSR S670 is a new common format. File extension "ppi".

Expansion Packs for the PSR A2000, PSR S750 and PSR S950 have the same format. File extension "yep".

Expansion Packs for PSR S650 is another format. File extension "yep".

The size of Expansion Packs is limited by the keyboards storing capacity.

Installation

The "ppi"/"yep" file is the installation file of the pack which goes into the keyboard.

Only one "ppi"/"yep" file can be installed in a keyboard at the same time.

However more "ppi"/"yep" files can be merged into one "ppi" file. See more below!

1.6.2 Software for Expansion Packs

Yamaha Expansion Manager (YEM)

For creating "ppi" files from different expansion packs; both "ppi" and "yep" file formats can be used - but only the styles of "yep" files.

The software creates a "ppf" file, which is the project file.

When you save this, the expansion manager software creates the "ppi" file.

Yamaha Expansion Manager (win) at

http://download.yamaha.com/search/detail/?site=dk.yamaha.com&language=da&category_id1=16277&category_id2=16084&product_id=1883956&asset_file_language=EN&asset_id=60255

Yamaha Expansion Manager (mac) at

http://download.yamaha.com/search/detail/?site=dk.yamaha.com&language=da&category_id1=16277&category_id2=16084&product_id=1883956&asset_file_language=EN&asset_id=61716

Styles In YEP/PPI Files

This software will extract the style files from Expansion Packs. No voice extraction!

Styles In YEP/PPI Files at <http://www.jososoft.dk/yamaha/software/yep/index.htm>

YEP Voice Manager

This software is for managing "yep" files. Adding/removing voices and/or styles.

YEP Voice Manager at http://www.jososoft.dk/yamaha/psr_soft/yep_voice_manager_v3.exe

Voice editing software

If the voice is in wave format you can use Goldwave at <http://www.goldwave.com/> or another Digital Audio Editor.

If it is uTG format... Sorry, no luck...

Expansion Voice Editor

This software is for creating "yep" files. This is a Yamaha software program. The program and the manual are not available for public. Sorry...

More about "yep"

A lot of information about "yep" files can be found at <http://www.psrtutorial.com/forum/index.php?topic=20016.0>

1.7 CASM High Limit and Low Limit

By design the style channel notes can be recorded / created in any octave.
When played back the notes can be redirected by settings in the CASM section.
This redirecting is controlled by the High Limit and Low Limit settings.
But too narrow limit settings might prevent octave shifting.
Changing the settings can be performed in the Style Creator.

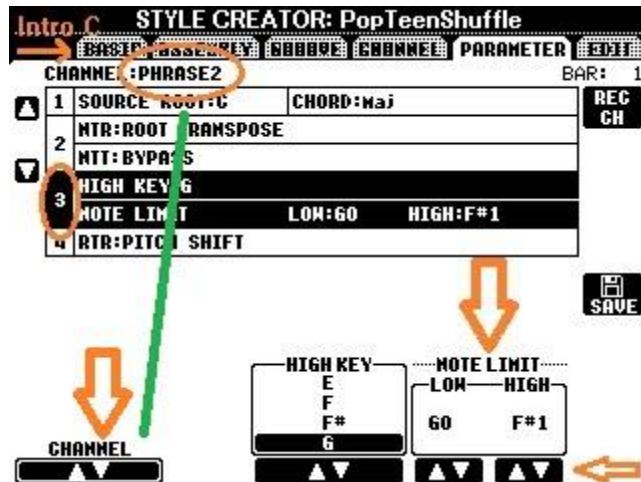

1. Select the style part where some change has to be performed, e.g. "Intro C" at the first tab.
2. Change to tab 5 "Parameter"
3. Change Channel to the channel to edit, e.g. PHRASE 2
4. Use arrows in the left side to select "3"
5. Now change values in "Note Limit"
6. AND SAVE...

With this option you can record in all octaves, and force the style to play back in a defined note area.

For obvious reasons you can not select an interval between the limits shorter than an octave...